



- ▲ Model MF100 is a sensor-USB interface that seamlessly connects a strain gage-based sensor to a PC for weighing, load measurement, and many other applications.



- ▲ Shown with a selection of compatible force and torque sensors.



- ▲ MF100 includes a tethered USB cable that plugs directly into a PC or USB hub. Shown here in a typical application with a load cell.

Connect strain gage-based load cells, force sensors, and torque sensors to a PC or USB hub using the Model MF100 USB Sensor Interface and MESUR®Flex configuration software.

MESUR®Flex supports a wide range of applications in weighing, force, and torque measurement. It accommodates force sensors from 0.12 to 750,000 lbF (0.5 N to 4,000 kN) and torque sensors from 10 ozFin to 40,000 lbFft (7 Ncm to 57,000 Nm). A built-in screw terminal block allows quick, solder-free connection of sensor wires to the interface.

Through MESUR®Flex, select the sensor's capacity, add a unique identifier, and calibrate the sensor through a step-by-step wizard.

The software contains basic settings for changing measurement units, viewing peak, real-time, and time-averaged data. Or, control the sensor and acquire data via an extensive library of serial commands, ideal for integration into a data collection system.

Features

- Connect strain gage-based load cells, force sensors, and torque sensors to a PC
- Screw terminal block allows for easy connection of sensor wires
- Configure sensor capacity, resolution, and identifier via MESUR®Flex
- View real-time, peak, and average load data, and zero (tare) and clear peaks with MESUR®flex
- Calibrate the sensor on a PC with an intuitive step-by-step interface in MESUR®Flex
- Extensive library of serial commands for third-party applications, including:
 - Output real-time and peak loads
 - High-speed data output up to 500 Hz
 - Load averaging
 - Zero (tare) and clear peaks
 - Read product identifiers, model, serial, and firmware numbers
 - Units selection

Simplified Interface to a PC

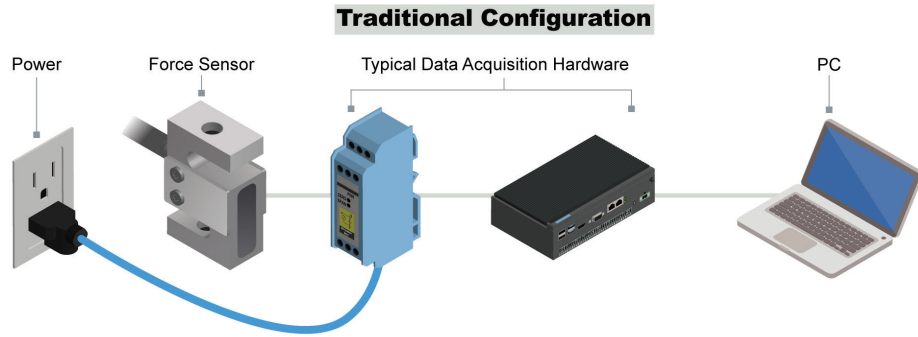

Simplified Configuration

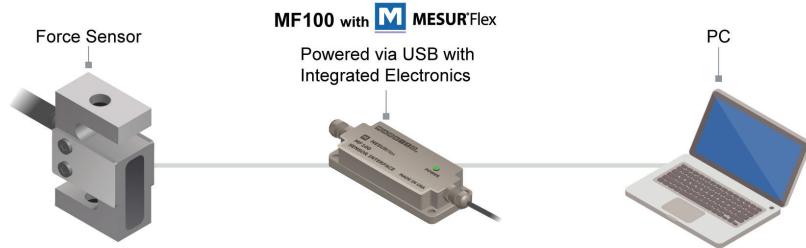

MESUR®Flex Software

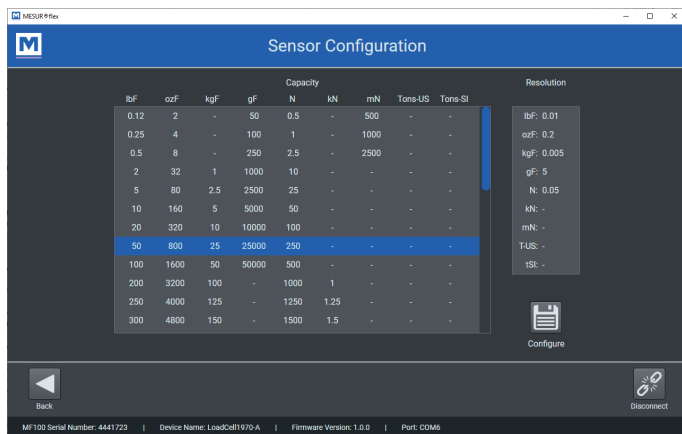

▲ Configure capacity, resolution, and an identifier via the setup utility.



▲ View real-time, peak, and average load data, and zero (tare) and clear peaks.

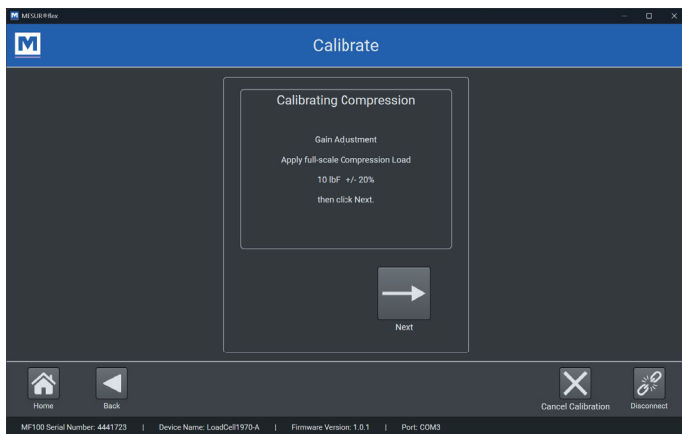

▲ Easy-to-use calibration wizard.

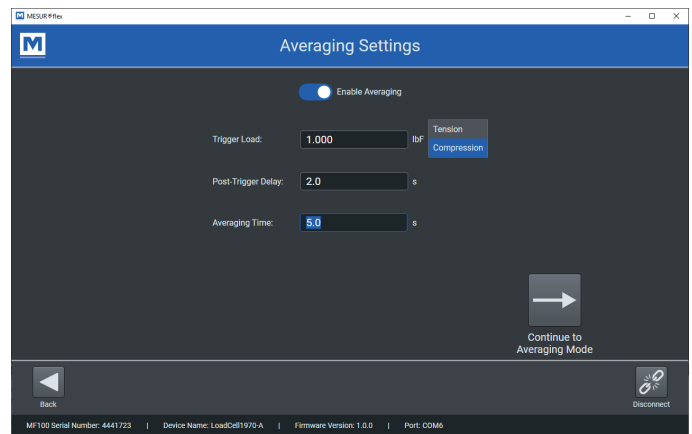

▲ Configure basic settings, such as unit of measurement and measurement mode.

Force Capacities & Resolutions

lbF	ozF	gF	kgF	N	kN	mN	T-US (US ton)	T-SI (metric ton)
0.12 x 0.00002	2 x 0.0005	50 x 0.01	-	0.5 x 0.0001	-	500 x 0.1	-	-
0.25 x 0.00005	4 x 0.001	100 x 0.02	-	1 x 0.0002	-	1000 x 0.2	-	-
0.5 x 0.0001	8 x 0.002	250 x 0.05	-	2.5 x 0.0005	-	2500 x 0.5	-	-
2 x 0.0005	32 x 0.005	1000 x 0.2	1 x 0.0002	10 x 0.002	-	-	-	-
5 x 0.001	80 x 0.02	2500 x 0.5	2.5 x 0.0005	25 x 0.005	-	-	-	-
10 x 0.002	160 x 0.02	5000 x 1	5 x 0.001	50 x 0.01	-	-	-	-
20 x 0.005	320 x 0.05	10000 x 2	10 x 0.002	100 x 0.02	-	-	-	-
50 x 0.01	800 x 0.2	25000 x 5	25 x 0.005	250 x 0.05	-	-	-	-
100 x 0.02	1600 x 0.2	50000 x 10	50 x 0.01	500 x 0.1	-	-	-	-
200 x 0.05	3200 x 0.5	-	100 x 0.02	1000 x 0.2	1 x 0.0002	-	-	-
250 x 0.05	4000 x 1	-	125 x 0.02	1250 x 0.2	1.25 x 0.0002	-	-	-
300 x 0.05	4800 x 1	-	150 x 0.02	1500 x 0.2	1.5 x 0.0002	-	-	-
500 x 0.1	8000 x 2	-	250 x 0.05	2500 x 0.5	2.5 x 0.0005	-	-	-
750 x 0.2	12000 x 2	-	375 x 0.1	3750 x 1	3.75 x 0.001	-	-	-
1000 x 0.2	16000 x 2	-	500 x 0.1	5000 x 1	5 x 0.001	-	-	-
1500 x 0.2	24000 x 5	-	750 x 0.2	7500 x 2	7.5 x 0.002	-	-	-
2000 x 0.5	32000 x 5	-	1000 x 0.2	10000 x 2	10 x 0.002	-	-	-
5000 x 1	-	-	2500 x 0.5	-	25 x 0.005	-	2.5 x 0.0005	2.5 x 0.0005
10000 x 2	-	-	5000 x 1	-	50 x 0.01	-	5 x 0.001	5 x 0.001
15000 x 2	-	-	7500 x 2	-	75 x 0.02	-	7.5 x 0.002	7.5 x 0.002
20000 x 5	-	-	10000 x 2	-	100 x 0.02	-	10 x 0.002	10 x 0.002
25000 x 5	-	-	10000 x 2	-	100 x 0.02	-	10 x 0.002	10 x 0.002
30000 x 5	-	-	15000 x 2	-	150 x 0.02	-	15 x 0.002	15 x 0.002
50000 x 10	-	-	25000 x 5	-	250 x 0.05	-	25 x 0.005	25 x 0.005
75000 x 20	-	-	40000 x 10	-	400 x 0.1	-	40 x 0.01	40 x 0.01
100000 x 20	-	-	50000 x 10	-	500 x 0.1	-	50 x 0.01	50 x 0.01
150000 x 20	-	-	75000 x 20	-	750 x 0.2	-	75 x 0.02	75 x 0.02
200000 x 50	-	-	100000 x 20	-	1000 x 0.2	-	100 x 0.02	100 x 0.02
250000 x 50	-	-	100000 x 20	-	1000 x 0.2	-	100 x 0.02	100 x 0.02
300000 x 50	-	-	150000 x 20	-	1500 x 0.2	-	150 x 0.02	150 x 0.02
500000 x 100	-	-	250000 x 50	-	2500 x 0.5	-	250 x 0.05	250 x 0.05
750000 x 200	-	-	400000 x 100	-	4000 x 1	-	400 x 0.1	400 x 0.1
1000000 x 200	-	-	500000 x 100	-	5000 x 1	-	500 x 0.1	500 x 0.1

Torque Capacities & Resolutions

lbFin	ozFin	lbFft	Ncm	Nm	Nmm	kgFmm	gFcm	kgFm	kgFcm
-	10 x 0.002	-	7 x 0.001	-	70 x 0.01	7 x 0.001	700 x 0.1	-	-
-	20 x 0.005	-	14 x 0.002	-	140 x 0.02	14 x 0.002	1400 x 0.2	-	-
-	50 x 0.01	-	35 x 0.005	-	350 x 0.05	35 x 0.005	3500 x 0.5	-	-
-	100 x 0.02	-	70 x 0.01	-	700 x 0.1	70 x 0.01	7000 x 1	-	-
-	1000 x 0.2	-	700 x 0.1	-	7000 x 1	700 x 0.1	70000 x 10	-	-
12 x 0.002	192 x 0.05	-	135 x 0.02	1.35 x 0.0002	-	-	-	-	13.5 x 0.002
20 x 0.005	320 x 0.05	-	220 x 0.05	2.2 x 0.0005	-	-	-	-	22 x 0.005
25 x 0.005	400 x 0.1	-	290 x 0.05	2.9 x 0.0005	-	-	-	-	29 x 0.005
50 x 0.01	800 x 0.2	-	570 x 0.1	5.7 x 0.001	-	-	-	-	57 x 0.01
100 x 0.02	1600 x 0.2	-	1150 x 0.2	11.5 x 0.002	-	-	-	-	115 x 0.02
150 x 0.02	-	12.5 x 0.002	1700 x 0.2	17 x 0.002	-	1700 x 0.2	-	-	-
200 x 0.05	-	16 x 0.002	2200 x 0.5	22 x 0.005	-	2200 x 0.5	-	-	-
250 x 0.05	-	20 x 0.005	2900 x 0.5	29 x 0.005	-	2900 x 0.5	-	-	-
400 x 0.1	-	32 x 0.005	4500 x 1	45 x 0.01	-	4500 x 1	-	-	-
500 x 0.1	-	40 x 0.01	5700 x 1	57 x 0.01	-	5700 x 1	-	-	-
600 x 0.1	-	50 x 0.01	6900 x 1	69 x 0.01	-	6900 x 1	-	-	-
1000 x 0.2	-	80 x 0.02	11500 x 2	115 x 0.02	-	11500 x 2	-	-	-
1500 x 0.2	-	125 x 0.02	17000 x 2	170 x 0.02	-	17000 x 2	-	-	-
2000 x 0.5	-	150 x 0.02	22000 x 5	220 x 0.05	-	22000 x 5	-	-	-
2500 x 0.5	-	200 x 0.05	29000 x 5	290 x 0.05	-	29000 x 5	-	-	-
5000 x 1	-	400 x 0.1	57000 x 10	570 x 0.1	-	57000 x 10	-	-	-
6000 x 1	-	500 x 0.1	69000 x 10	690 x 0.1	-	69000 x 10	-	-	-
10000 x 2	-	800 x 0.2	115000 x 20	1150 x 0.2	-	-	-	115 x 0.02	-
15000 x 2	-	1250 x 0.2	170000 x 20	1700 x 0.2	-	-	-	170 x 0.02	-
20000 x 5	-	2000 x 0.5	220000 x 50	2200 x 0.5	-	-	-	220 x 0.05	-
50000 x 10	-	4000 x 1	570000 x 100	5700 x 1	-	-	-	570 x 0.1	-
100000 x 20	-	8000 x 2	-	11500 x 2	-	-	-	1150 x 0.2	115000 x 20
150000 x 20	-	12500 x 2	-	17000 x 2	-	-	-	1700 x 0.2	170000 x 20
200000 x 50	-	15000 x 2	-	22000 x 5	-	-	-	2200 x 0.5	220000 x 50
500000 x 100	-	40000 x 10	-	57000 x 10	-	-	-	5700 x 1	570000 x 100

Specifications

Sensor compatibility:	
Type:	Full bridge
Resistance:	300 - 1,000Ω
Sensitivity:	1 - 3 mV/V full scale
Force range:	0.12 lbf - 500 T [0.5 N - 5,000 kN]
Torque range:	10 ozFin - 40,000 lbfFt [7 Ncm - 57,000 Nm]
Load accuracy:	±0.1% of full scale + sensor
Load sampling rate:	7,000 Hz
Data output rate:	Up to 500 Hz, user-configurable
Weight:	0.4 lb [0.2 kg]
Environmental requirements:	40 - 100°F, max. 96% humidity, non-condensing
Conformance:	CE, UKCA
Warranty:	3 years (see individual statement for further details)

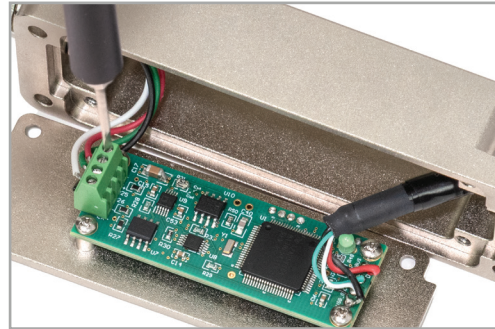

▲ Easily connect sensor wires via screw terminal blocks. No soldering or special tools required.

Dimensions in [mm]

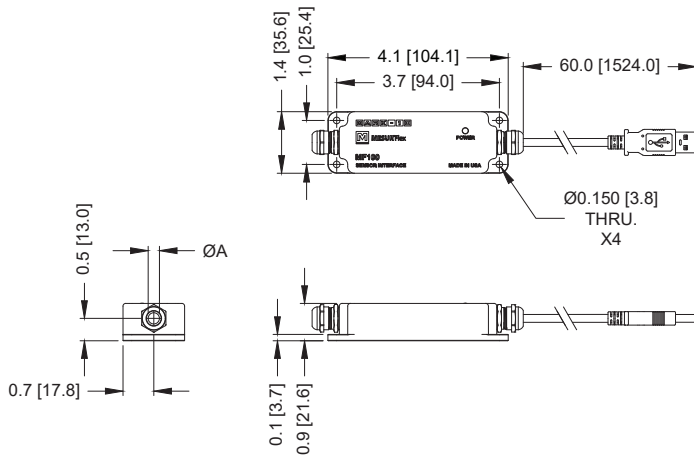

In The Box

The MF100 includes the following:

- (1) 5' [1.5 m] tethered USB cable
- (1) Strain relief for sensor cable
- (1) Quick start guide with MESUR®Flex software download link
- (1) Certificate of calibration

Ordering Information

Model	Description
MF100	USB sensor interface